

1

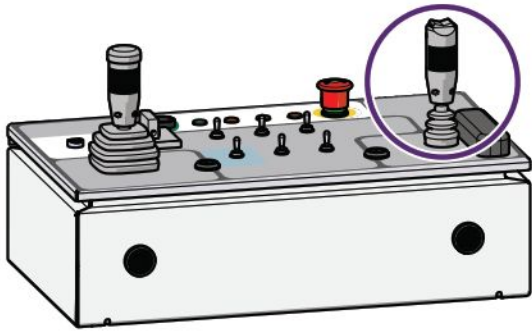

2

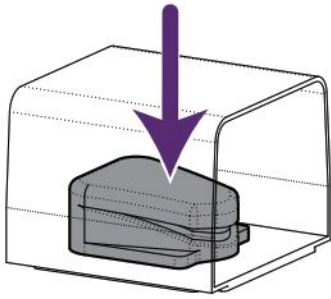
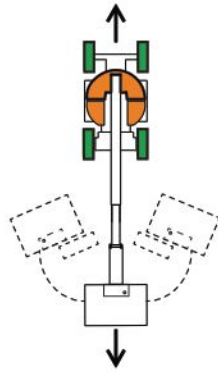

3

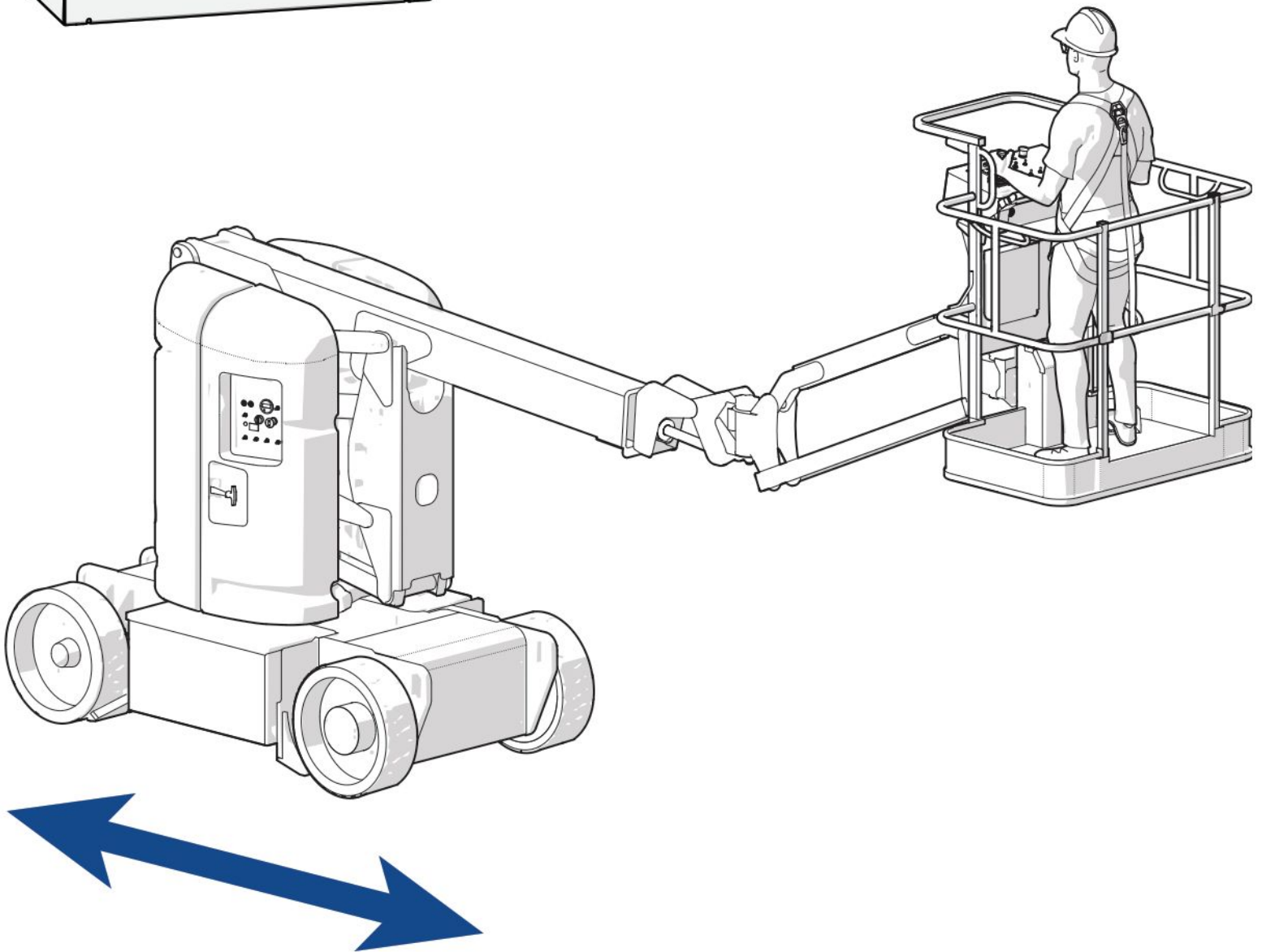
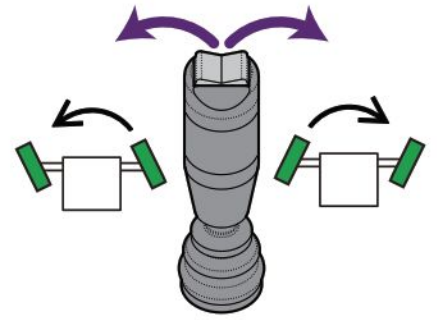

1

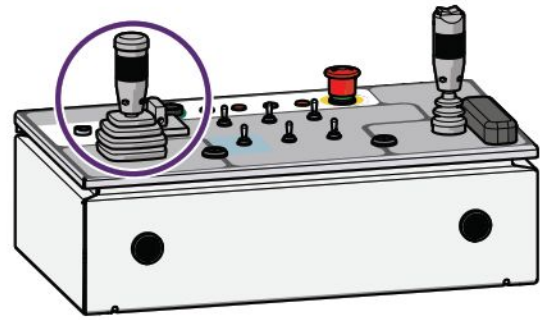
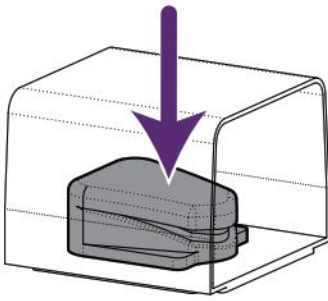

2

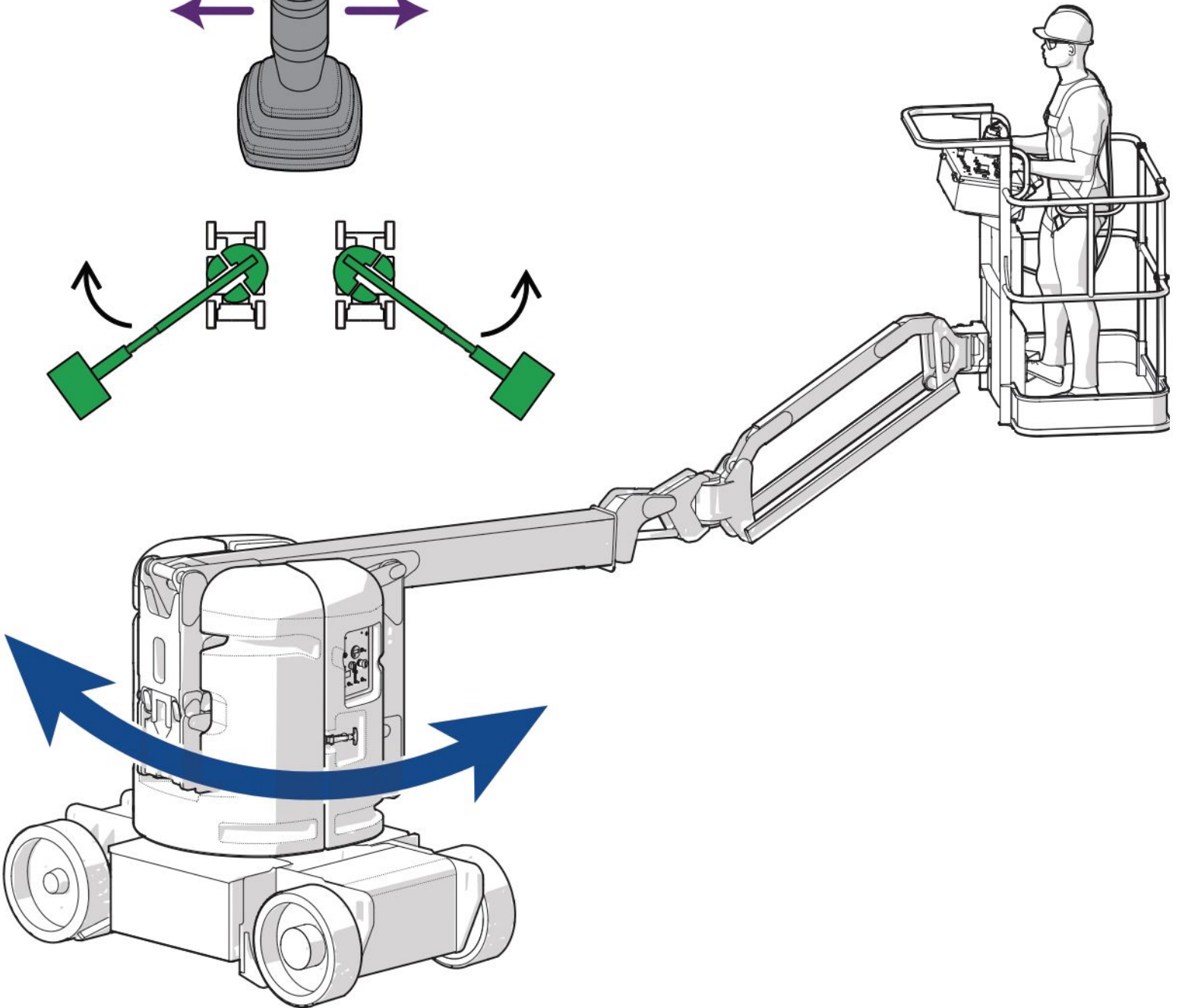
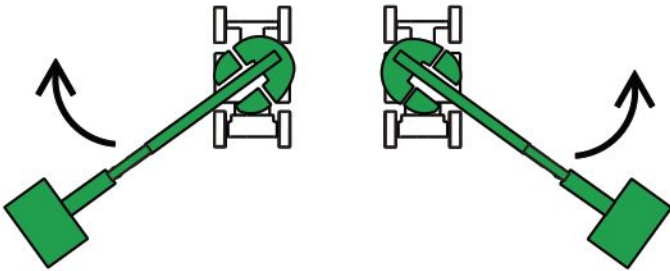
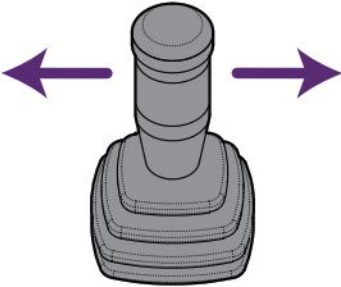

1

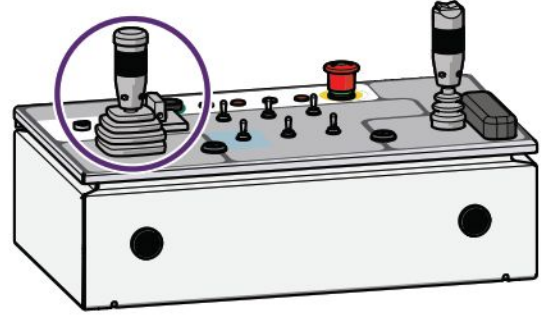
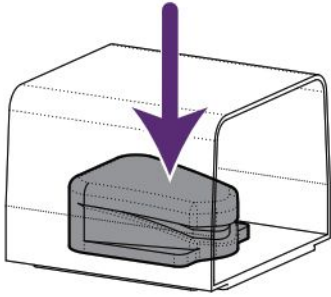

2

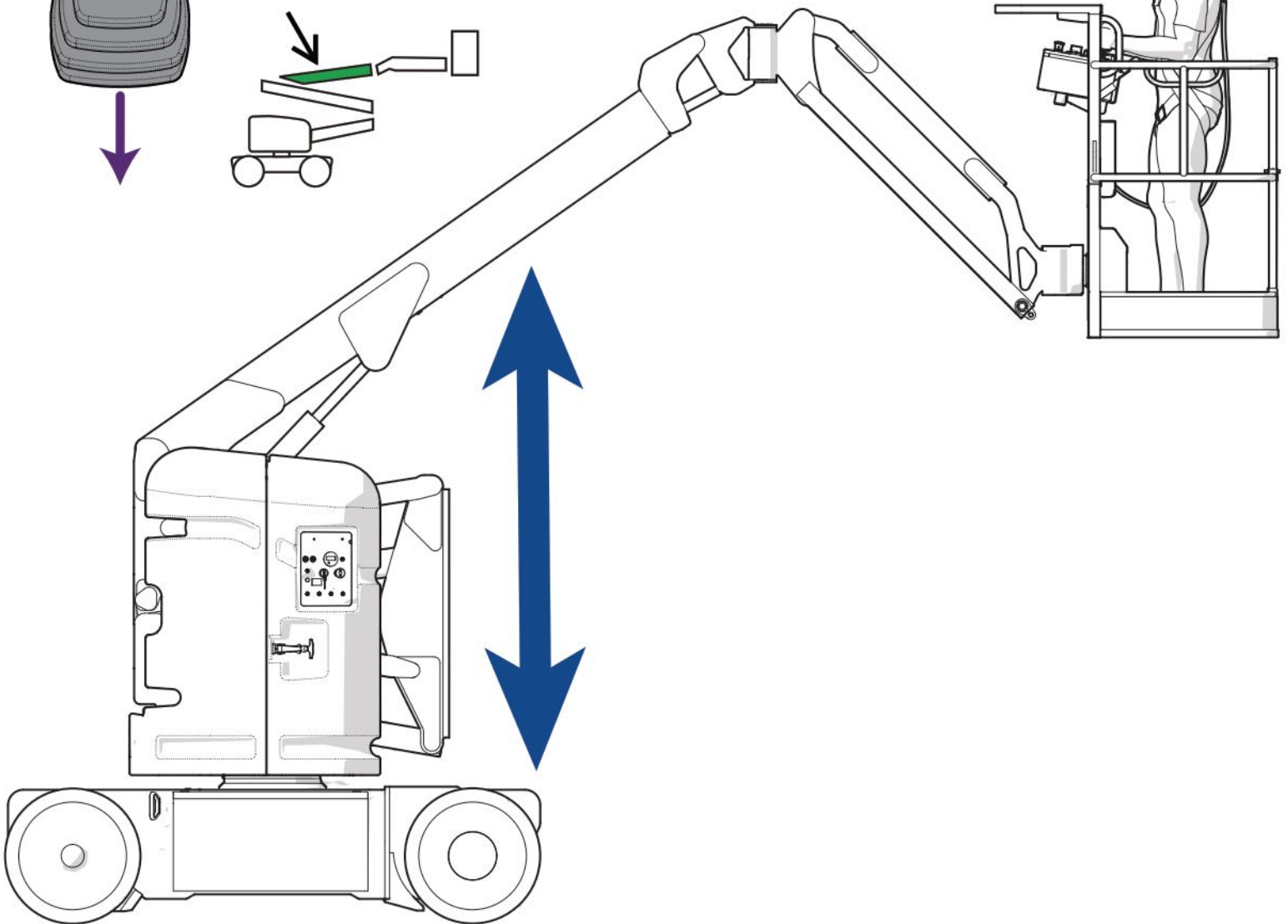
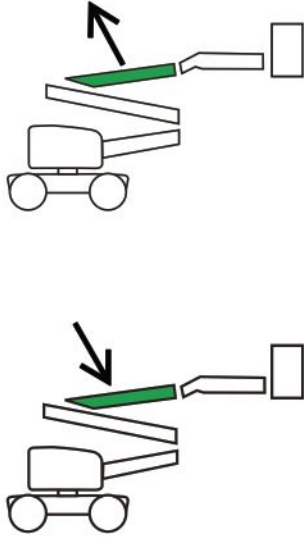
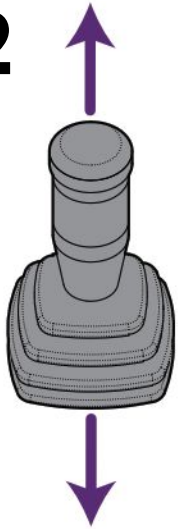

1

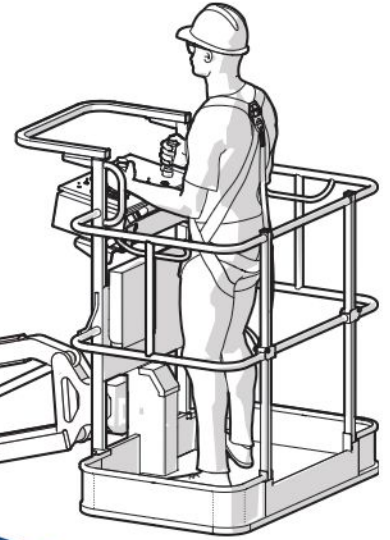
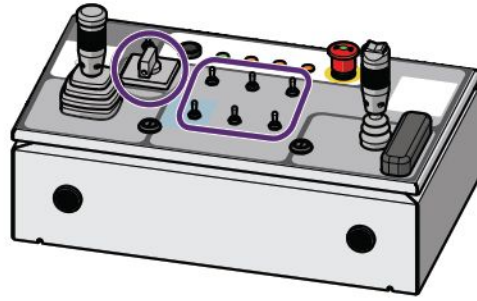
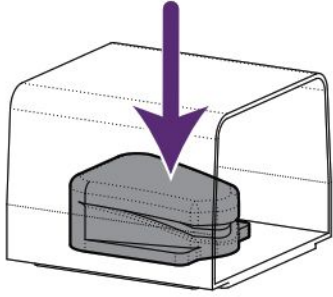

2

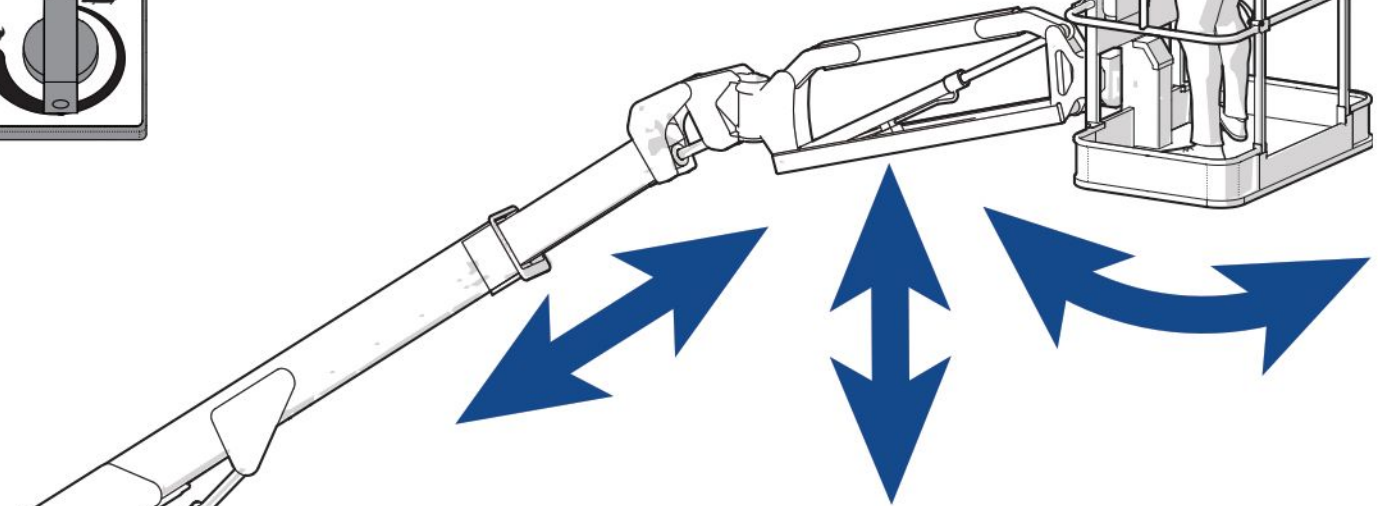

3

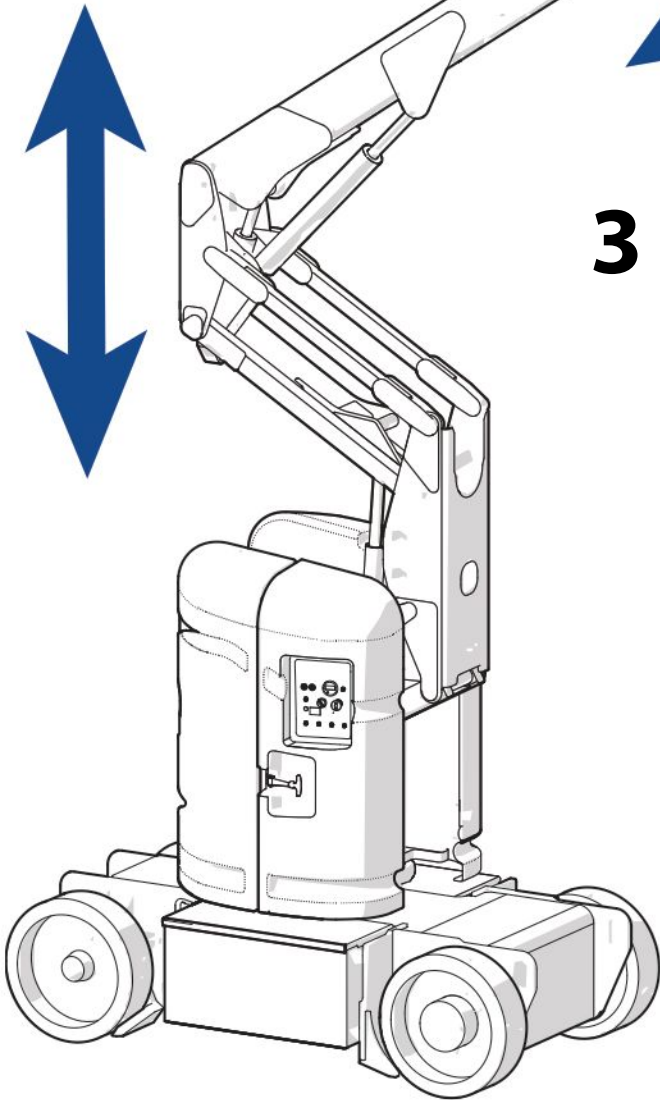
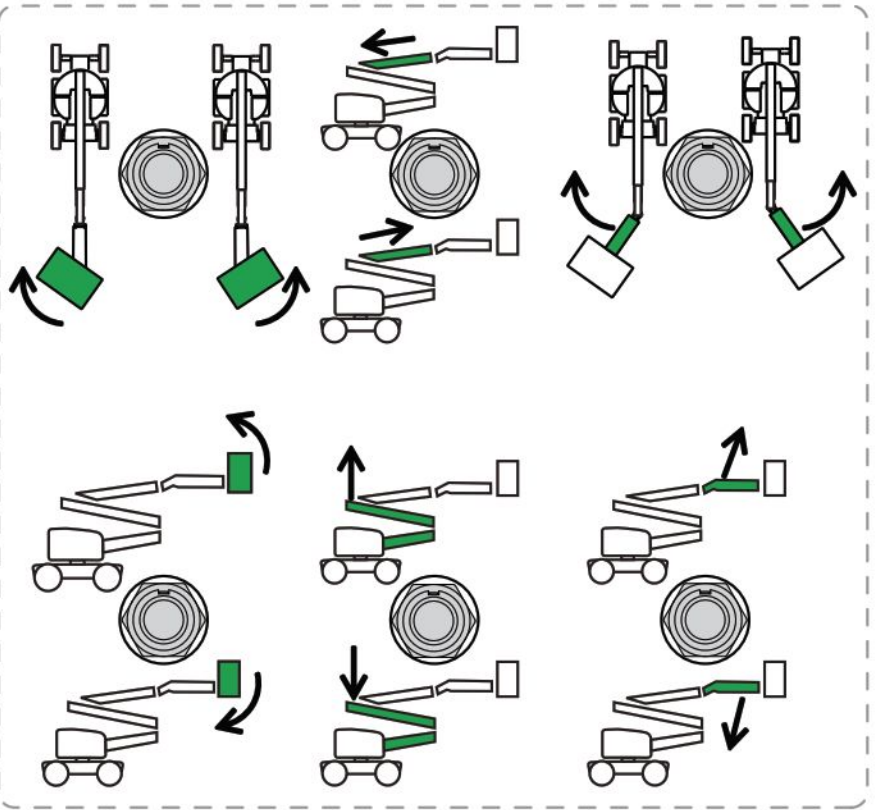

1



2

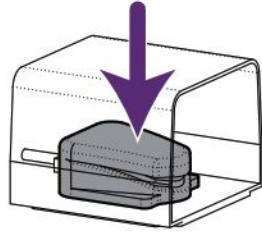

3

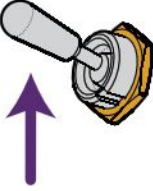

4

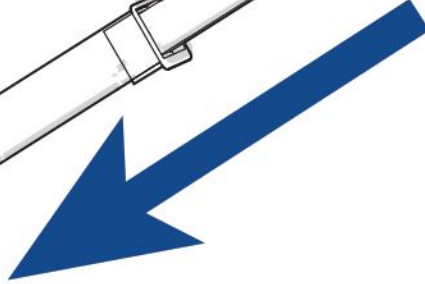
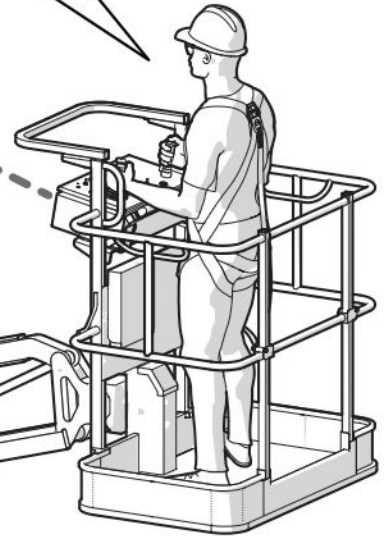
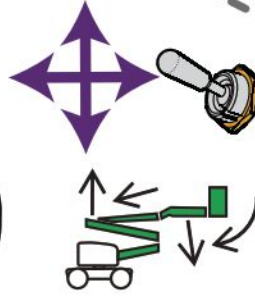
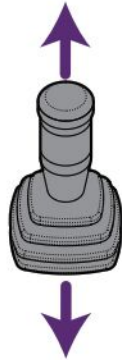

1

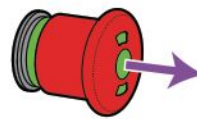

2

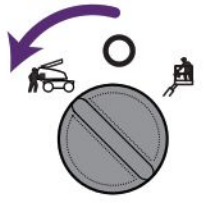

3

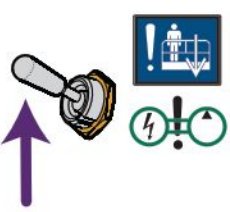

4

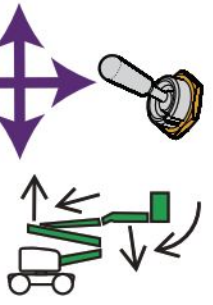

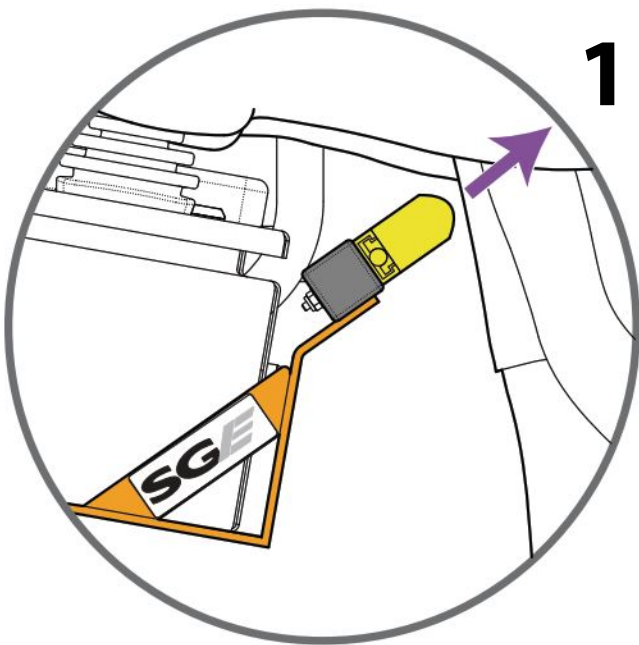
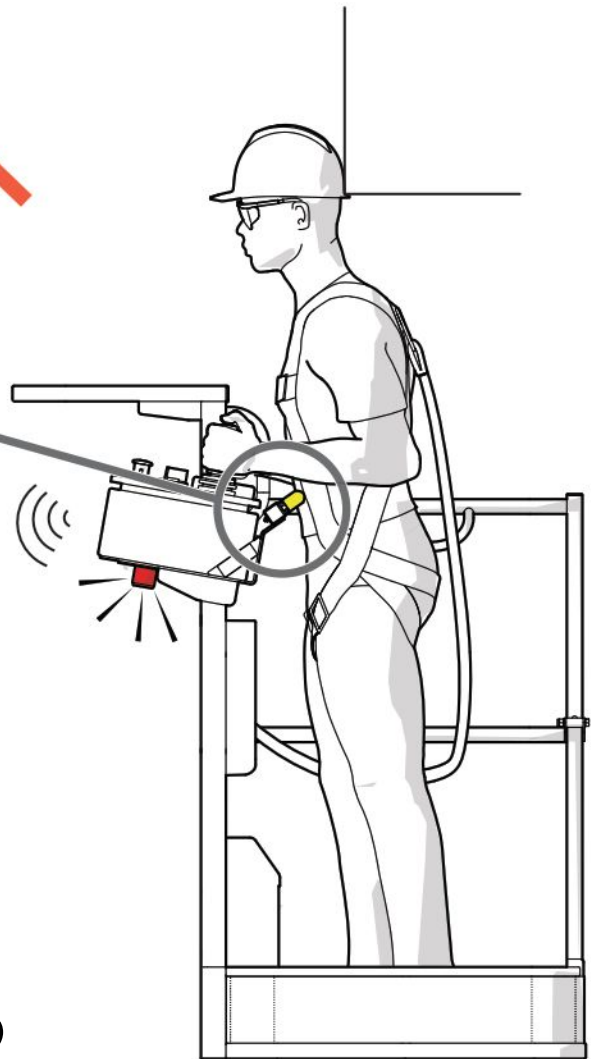
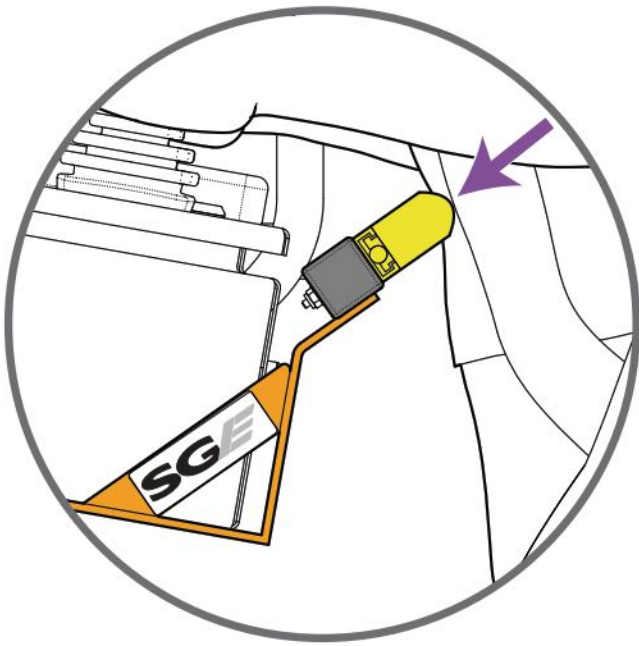

1

2

